



塑膠廢料回收整廠設備
COMPOUND EXTRUDER SERIES
廢プラスチック造粒設備
Professional Recycling Plant Manufacturer



Salvage Oriented for the Nonpareil Globe Multiform Implements for the Noble Garbage



Contributing to the World Through Recycling Plants

崧明全產品系列機型

1. Waste Plastic (PP, PE, PS & ABS)

Recycling Plant: double de-gasing model

廢塑料—回收整廠設備：雙脫氣式

2. Bag / Film

Recycling Plant: die face cutting model

薄膜袋料—回收整廠設備：模頭切粒式

3. Materbatch

Pelletizing Plant

色母製粒整廠設備

4. TPR / EVA / PVC / RUBBER

Compound Pelletizing Plant

TPR / EVA / PVC / 橡膠 製粒整廠設備

5. Recycling Peripherales

Granulators, Shredder, Vertical Mixers,

Knife Grinders and Hydraulic Cutters

廢料回收用周邊設施：

粉碎機、破碎機、直立式混合機、

磨刀機及油壓裁斷機

6. Pelletizing Peripherales

PVC Hi-speed Mixers, Blenders and

Pellet Cutting Machines

製粒用周邊設施：

高速混合機、臥式攪拌桶及切粒機

7. Other Recycling Plant

Tires, PET Bottles and Copper Wires

其他環保回收整廠設備：

廢輪胎、PET瓶與廢電線、電纜回收設備

Waste Plastic Recycling Plant: Double De-gasing Model

廢塑料回收造粒設備

適用：PP, LDPE, HDPE, LLDPE, PS, ABS

- ① GRANULATOR 粉碎機
- ② BLOWER 風車
- ③ CYCLONE SEPARATER 集塵桶
- ④ SCREW CONVEYOR 螺旋輸送機
- ⑤ MAIN EXTRUDER 押出母機
- ⑥ SUB-EXTRUDER 押出子機
- ⑦ COOLING WATER TUNNEL 冷卻水槽
- ⑧ MATERIAL RACK BLOWER 風車過水架
- ⑨ PELLET CUTTER 切粒機
- ⑩ BLOWER 風車
- ⑪ STORAGE BARREL 成品儲料桶

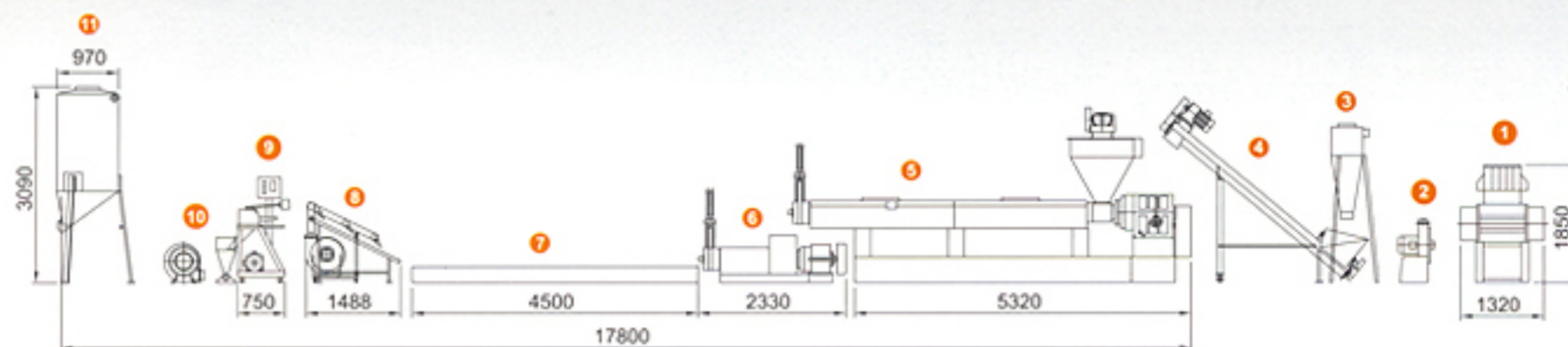

上部進料 TOP FEEDING



側邊進料 SIDE FEEDING

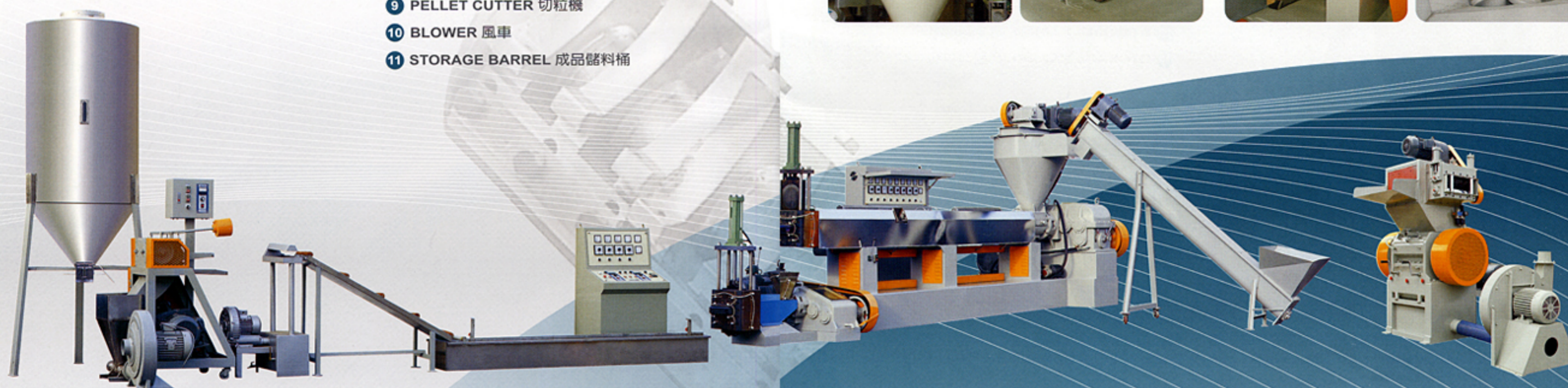

Model 型號	Granulator 粉碎機		Blower 風車	Screw Conveyor 螺旋輸送機			Main Extruder 押出主機						Sub-extruder 押出子機			Cooling Tunnel 冷卻槽	Blower 風車過水架	Pellet Cutter 切粒機		Blower 風車	Storage Barrel 成品儲料桶		
	Model 型式	Power 動力	Power 動力	Power 動力	size 尺寸	L/D Ratio 螺旋軸長徑比	Main power 主機動力	Speed Control 速度調整	Temp. Control 溫度控制	Heating Capacity 電熱容量	Hydraulic Power 模頭油壓動力	inforcing Hopper 強壓漏斗動力	Capacity 工作量	L/D Ratio 螺旋軸長徑比	Power 動力	Speed Control 速度調整	Heating Capacity 電熱容量	Size 尺寸	Power 動力	Power 動力	Speed Control 速度調整	Power 動力	Capacity 容量
SM-90WPR	SM-A15	20HP	5HP	3HP	80-3.5m	28:1	30 HP	變頻器 Inverter	5 zones	40 KW	3HP	5HP	50-100 kg/hr	1:8	10-15 HP	變頻器 Inverter	15 KW	8'x1.2'x1'	3HP	5HP	變頻器 Inverter	3HP	1000 L
SM-100WPR	SM-A21	20HP	5HP	3HP	80-3.5m	28:1	40-60 HP	變頻器 Inverter	6 zones	50 KW	3HP	5HP	100-150 kg/hr	1:8	15-20HP	變頻器 Inverter	20 KW	8'x1.2'x1'	3HP	5HP	變頻器 Inverter	3HP	1000 L
SM-120WPR	SM-A21	40HP	7.5HP	3HP	80-3.5m	30:1	75-100 HP	變頻器 Inverter	7 zones	60 KW	5HP	7.5HP	250-350 kg/hr	1:8	20-30 HP	變頻器 Inverter	25 KW	10'x1.2'x1.1'	3HP	7.5HP	變頻器 Inverter	5HP	1000 L
SM-150WPR	SM-A25	50HP	7.5HP	3HP	80-3.5m	32:1	125-200 HP	變頻器 Inverter	8 zones	70 KW	5HP	7.5HP	300-400 kg/hr	1:8	40-60 HP	變頻器 Inverter	30 KW	15'x1.2'x1.1'	3HP	10HP	變頻器 Inverter	5HP	1000 L

Bag/Film Recycling Plant: Die-face Cutting Model

薄膜袋料回收整廠設備

適用：PE, LDPE, LLDPE, HDPE

- 1 GRANULATOR 粉碎機
- 2 BLOWER 風車
- 3 BLENDING TANK 臥式攪拌機
- 4 SCREW CONVEYOR 螺旋輸送機
- 5 EXTRUDER 押出母機
- 6 SUB EXTRUDER 押出子機
- 7 SEPARATOR 脫水機
- 8 VIBRATING SCREENER 震動篩選機
- 9 BLOWER 風車
- 10 STORAGE BARREL 成品儲料桶

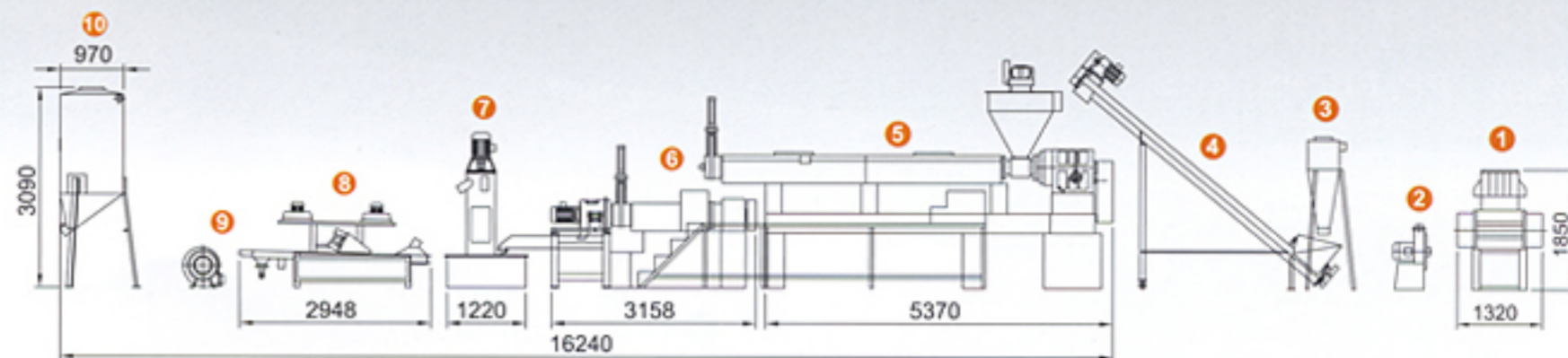

上部進料 TOP FEEDING



側邊進料 SIDE FEEDING

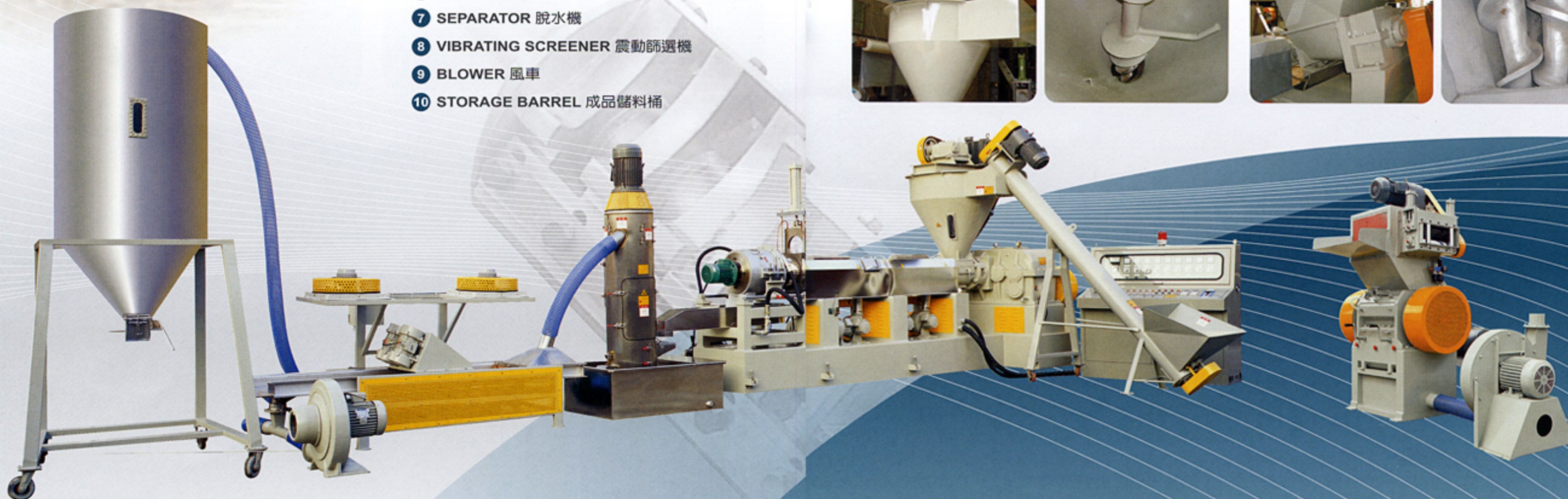
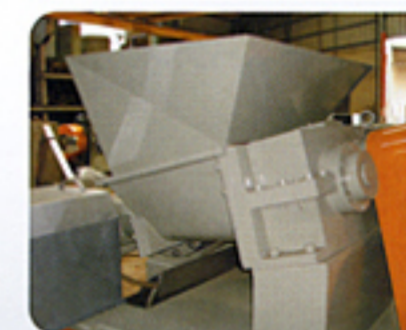

Model 型號	Granulator 粉碎機		Blower 風車		Screw Conveyor 螺旋輸送機		Main Extruder 押出主機						Sub-extruder 押出子機			Vibrating Screener 震動篩選機			Storage Barrel 成品儲料桶			
	Model 型式	Power 動力	Power 動力	Power 動力	size 尺寸	L/D Ratio 螺旋軸長徑比	Power 主機動力	Speed Control 速度調整	Temp. Control 溫度控制	Heating Capacity 電熱容量	Hydraulic Powerforcing Hopper 模頭油壓動澆壓澆斗動力	Capacity 工作量	L/D Ratio 螺旋軸長徑比	Power 動力	Speed Control 速度調整	Heating Capacity 電熱容量	Power of Die-Cutter 模頭切刀馬力	Water Pump 抽水馬達	Cooling Fan 風扇	Blower 風車	Capacity 容量	
SM-90FDC	SM-A15	20HP	5HP	3HP	8Ø - 3.5m	28:1	30-40 HP	變頻器 Inverter	5 zones	30 KW	3HP	5HP	100-150 kg/hr	1:8	10-15 HP	變頻器 Inverter	15 KW	3 HP	2 HP	0.25HP X 2	3HP	1000 L
SM-100FDC	SM-A21	20HP	5HP	3HP	8Ø - 3.5m	28:1	40-60 HP	變頻器 Inverter	6 zones	40 KW	3HP	5HP	150-200 kg/hr	1:8	15-20HP	變頻器 Inverter	20 KW	3 HP	2 HP	0.25HP X 2	3HP	1000 L
SM-120FDC	SM-A21	40HP	7.5HP	3HP	8Ø - 3.5m	30:1	75-100 HP	變頻器 Inverter	8 zones	55 KW	5HP	7.5HP	200-250 kg/hr	1:8	20-30 HP	變頻器 Inverter	25 KW	3 HP	2 HP	0.25HP X 2	5HP	1000 L
SM-150FDC	SM-A25	50HP	7.5HP	3HP	8Ø - 3.5m	32:1	125-200 HP	變頻器 Inverter	10 zones	70 KW	5HP	7.5HP	280-350 kg/hr	1:8	40-60 HP	變頻器 Inverter	30 KW	3 HP	2 HP	0.25HP X 2	5HP	1000 L

UNDERWATER PELLETIZING PLANT

水中造粒設備

適用：PP, PE, PS, ABS, PLA, PU

- ① FEEDER 餵粉機
- ② MAIN EXTRUDER 押出主機
- ③ UNDERWATER DIE-CUTTING SET 水中切粒
- ④ SEPARATOR 脫水機
- ⑤ VIBRATING SCREENER 震動篩
- ⑥ BLOWER 風車
- ⑦ STORAGE BARREL 成品儲料桶

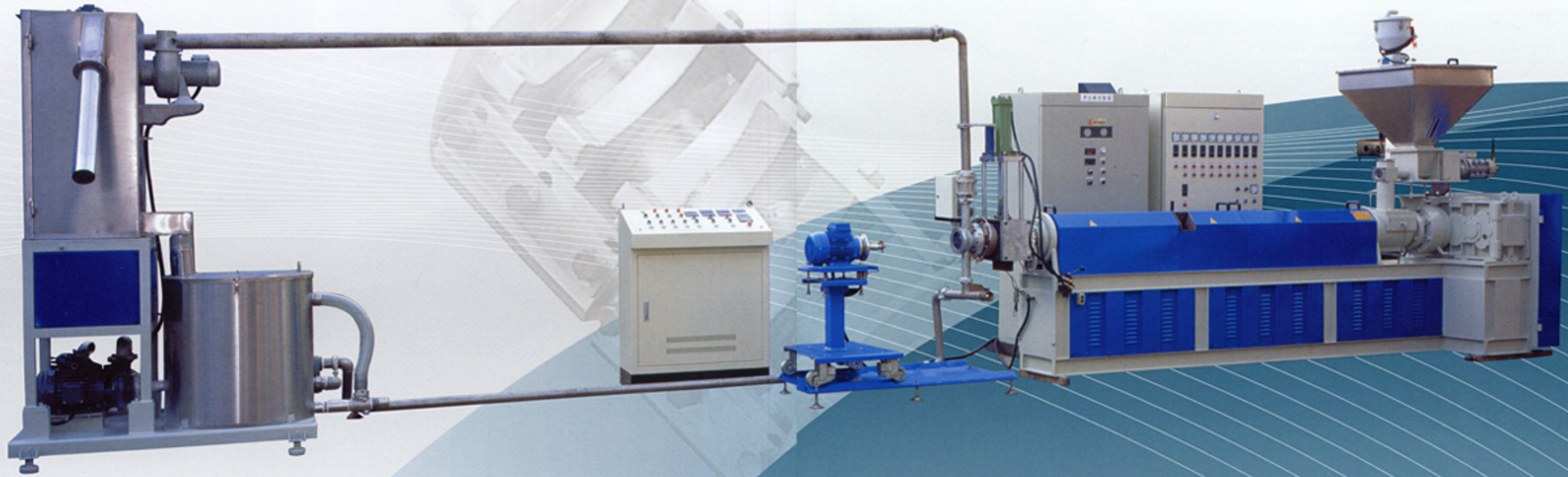
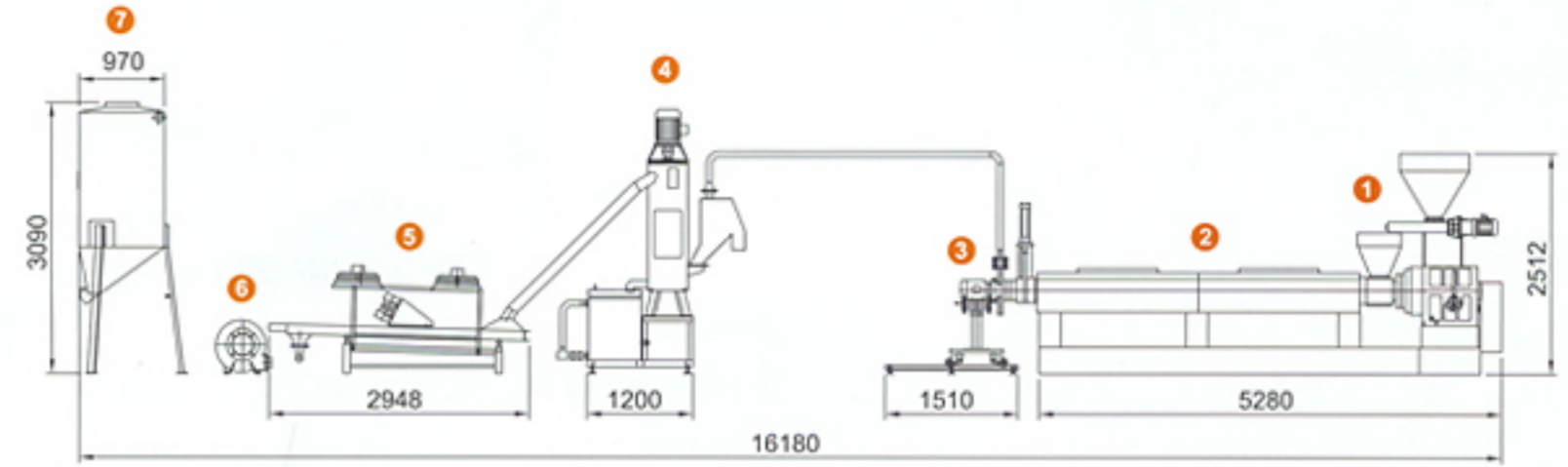

Model 型號	Feeder 餵粉機		Main Extruder 押出主機					Separator 脫水機	Vibrating Screener 震動篩	Blower 風車	Storage Barrel 成品儲料桶				
	Power 馬力	Speed Control 速度調整	L/D Ratio L/D (螺桿長徑比)	Main power 主機動力	Speed Control 速度調整	Capacity 產量	Heating Capacity 電熱容量	Die-cutter Power 切刀馬力	Speed Control 速度調整	Hydraulic Screen Changer 模頭換網馬力	Water Pump 抽水馬達	Power 馬力	Power 馬力	Power 馬力	Capacity 容量
SM-90U	0.5 HP	變頻器 Inverter	1:28	60 HP	變頻器 Inverter	100-150KG/HR	40 KW	3HP	變頻器 Inverter	3 HP	2 HP	5 HP	0.25HP X 2	3HP	1000 L
SM-100U	0.5 HP	變頻器 Inverter	1:28	75 HP	變頻器 Inverter	150-200KG/HR	50 KW	3HP	變頻器 Inverter	3 HP	2 HP	5 HP	0.25HP X 2	3HP	1000 L
SM-120U	1 HP	變頻器 Inverter	1:32	100 HP	變頻器 Inverter	200-250KG/HR	60 KW	5HP	變頻器 Inverter	5 HP	2 HP	10 HP	0.25HP X 2	5HP	1000 L
SM-150U	1 HP	變頻器 Inverter	1:32	150 HP	變頻器 Inverter	300-400KG/HR	70 KW	5HP	變頻器 Inverter	5 HP	2 HP	10 HP	0.25HP X 2	5HP	1000 L

直立式混合機

VERTICAL MIXER

SPECIFICATIONS 規格

Model	Power (HP)	Handling Capacity	Machine Size	Machine Wt.
型式	動力	處理量	機械尺寸	機械重量
SM-50M	3HP	50 kgs	950 x 740 x 1120 mm	250 kgs
SM-100M	5HP	100 kgs	950 x 1070 x 1250 mm	300 kgs
SM-200M	3HP x 2	200-250 kgs	1450 x 800 x 1150 mm	400 kgs
SM-350M	5HP x 2	350-400 kgs	1780 x 950 x 1300 mm	550 kgs
SM-550M	7.5HP x 2	550-600 kgs	2000 x 1100 x 1600 mm	850 kgs



L型混合機

L-TYPE MIXER

SPECIFICATIONS 規格

Model	Power (HP)	Handling Capacity	Machine Size	Machine Wt.
型式	動力	處理量	機械尺寸	機械重量
SM-25L	1/2HP	25 kgs	950 x 600 x 1200 mm	80 kgs
SM-50L	1/2HP	50 kgs	1125 x 875 x 1375 mm	110 kgs
SM-100L	1HP	100 kgs	1250 x 875 x 1500 mm	130 kgs

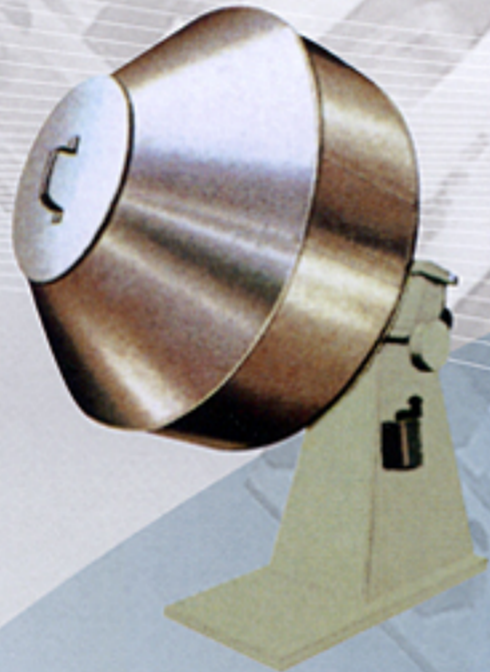

油壓裁斷機

HYDRAULIC CUTTER

SPECIFICATIONS 規格

Model	型式	SM-15C
Power	能力	7.5 HP
Max. Cutting Ht	最大裁切高度	800 mm
Max. Cutting Width	最大裁切寬度	1000 mm
Max. Output	最大出力	1500 kgs
Machine Weight	機械重量	1400 kgs
Machine Size	機械尺寸	1400 x 800 x 3200 mm

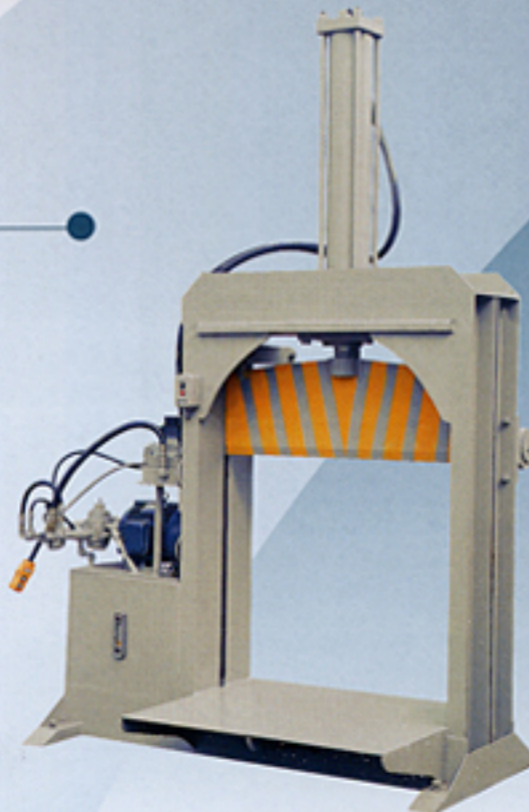

磨刀機

KNIFE GRINDER

SPECIFICATIONS 規格

Model	型式	SM-26G
Grinding Capacity	研磨能力	660 x 127 x 15.8 mm
Grinding Power	研磨動力	2HP
Grinding Wheel Size	砂輪尺寸	Ø150 x 100 x Ø25.4mm
Machine Size	機械尺寸	1120 x 860 x 960mm
Machine Wt.	機械重量	280kgs

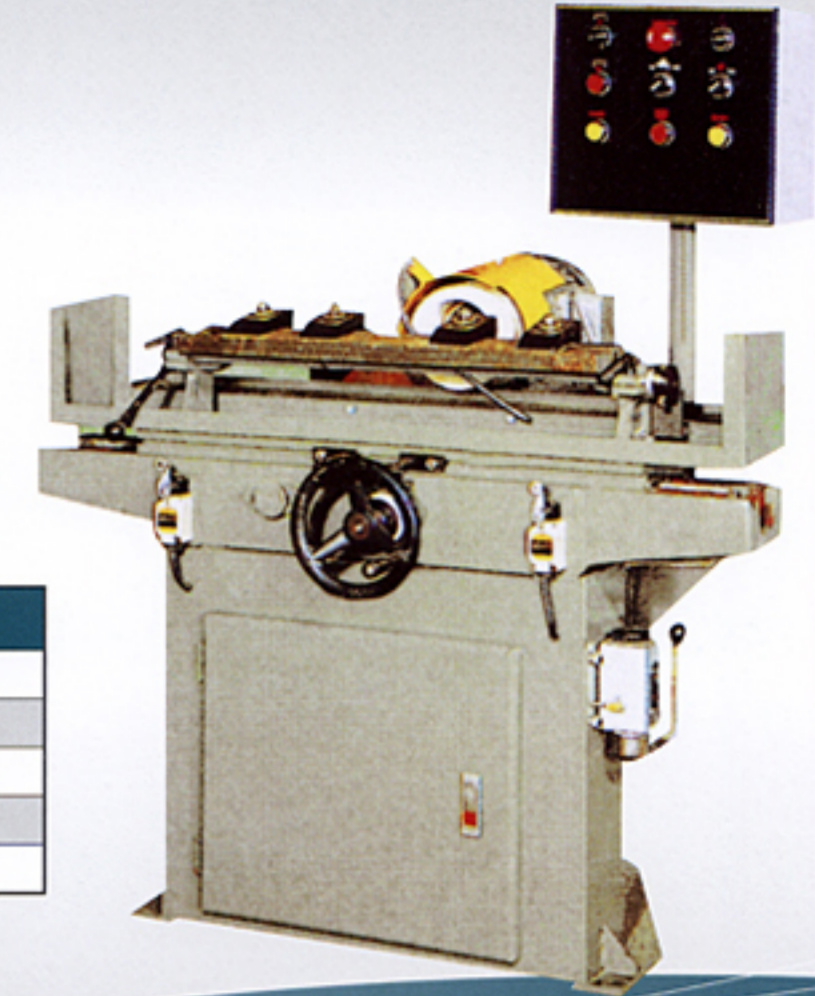

臥式攪拌桶

BLENDED TANK

SPECIFICATIONS 規格

Model	Power (HP)	Plate Thickness (MM)	Axial (MM)	Bearing	Tank Size (MM)	Capacity (LITER)	Machine Size (MM)	Net Weight (KG)
型式	動力	鋼板厚度	主軸	培林	桶內尺寸	容量	機械尺寸	淨重
SM-D400	5	4	55	ASAHI UCF211	1500 x 750 x 900	895	1740 x 870 x 1600	600
SM-D600	7.5	5	65	ASAHI UCF213	1525 x 900 x 1050	1310	1825 x 1050 x 2000	750
SM-D1000	15	6	75	ASAHI UCF215	1800 x 1200 x 1300	2530	3200 x 1320 x 2200	1800
SM-D2000	20	8	100	ASAHI UCF*20	2100 x 1500 x 1560	4685	3500 x 1650 x 2700	2700

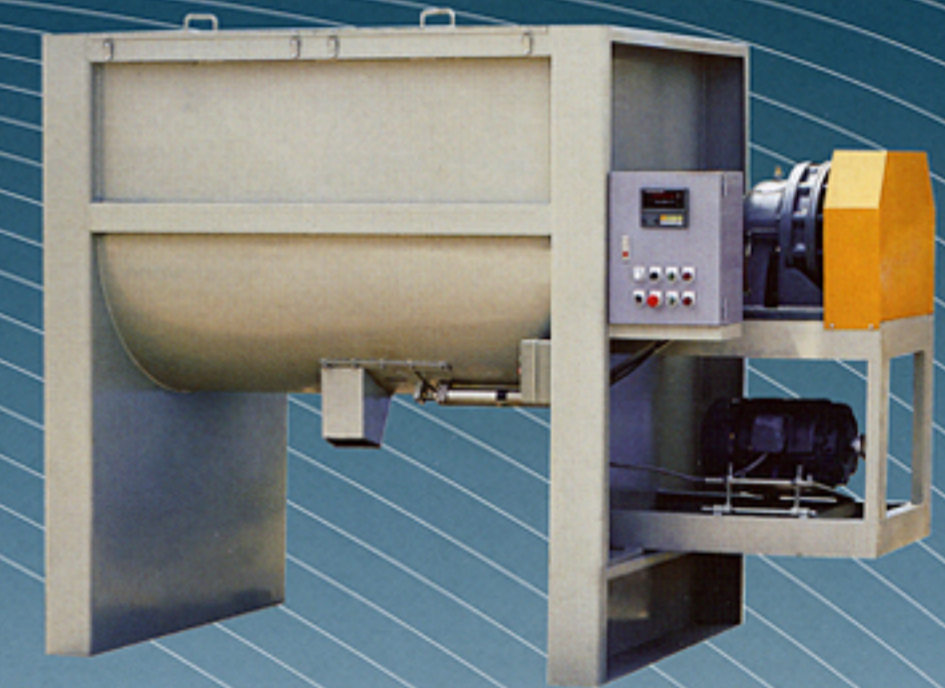

The above specifications and dimensions are for referencing purpose only. These figures are subject to change without prior notice. 以上圖片及規格，僅供參考之用。



SongMing

Professional Recycling Plant Manufacturer



SongMing

崧明機械工業有限公司
Song Ming Machinery Ind., Co., Ltd.

台灣台中縣龍井鄉忠和村工業路182號15弄5號
No. 5, Alley 15, Lane 182, Kung Yia Rd., Chung Ho Village,
Lung Ching 434 Taichung Taiwan R.O.C.

TEL: +886-4-2639 8161

FAX: +886-4-2639 8162

E-mail: sonmin@ms16.hinet.net

<http://www.songming.com.tw>